

ЛАБОРАТОРНАЯ РАБОТА
Модели на графах

№ 7 Расчет и анализ параметров сетевого графика

№ 8 Нахождение наикратчайшего пути в графе

№ 9 Задача о максимальном потоке в сети

(в №8 и №9 - добавить ориентацию от вершин с меньшими номерам к вершинам с большими номерами)

ЗАДАНИЯ:

1)

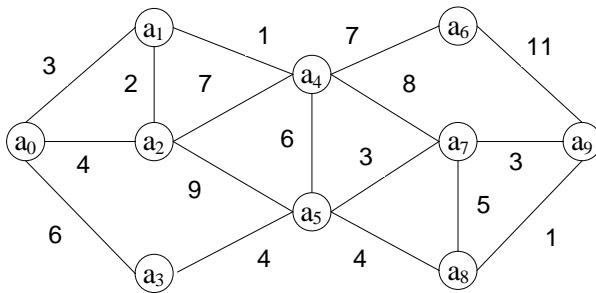

2)

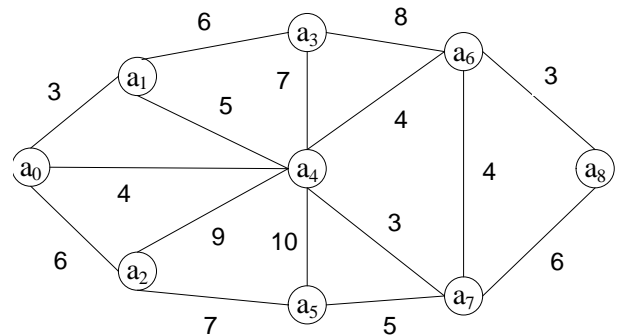

:

3)

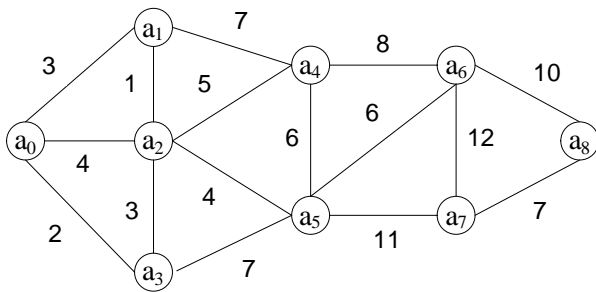

4)

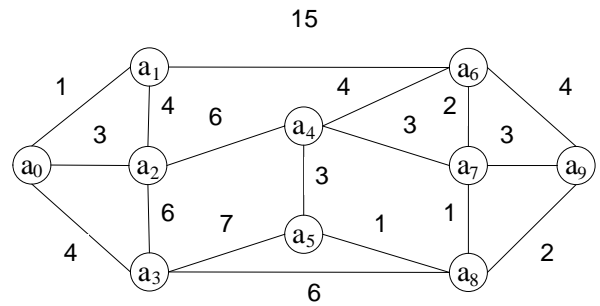

5)

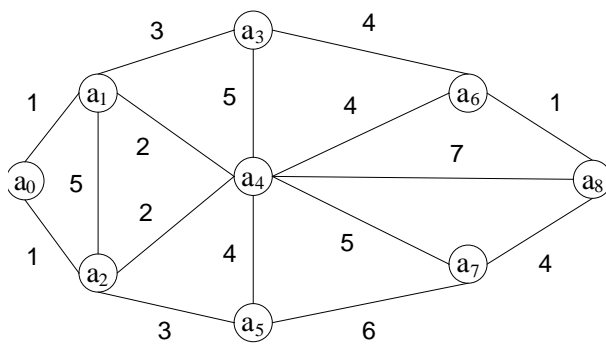

6)

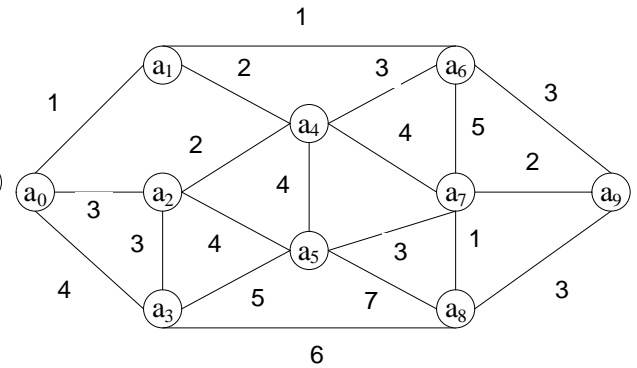

7)

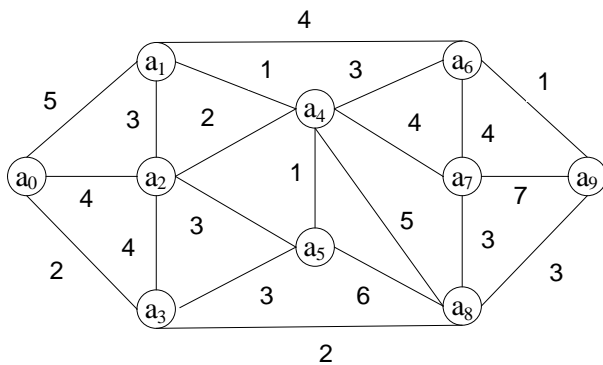

8)

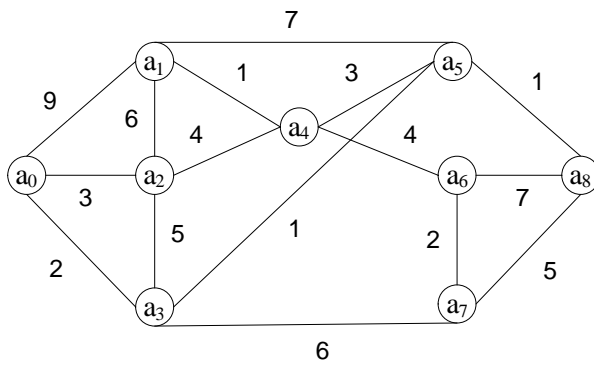

9)

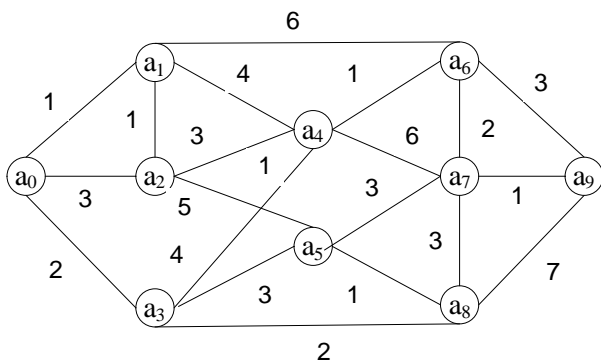

10)

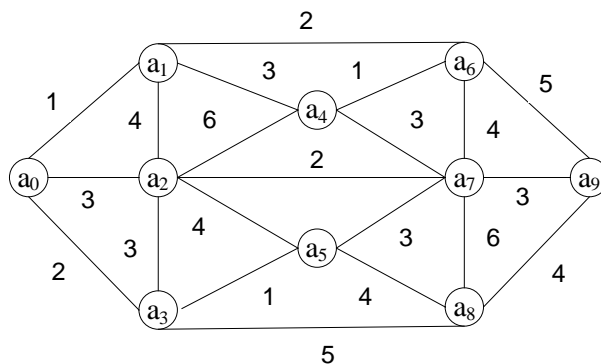

11)

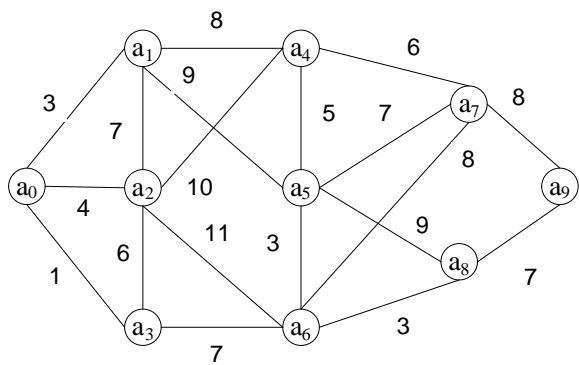

12)

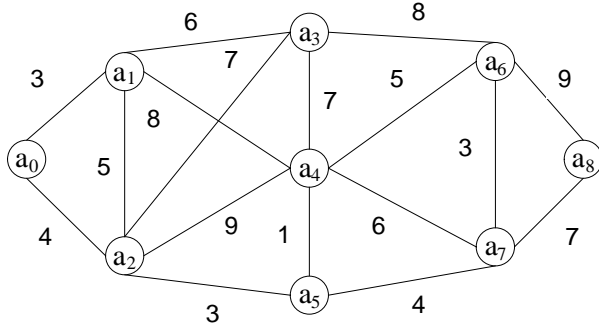

13)

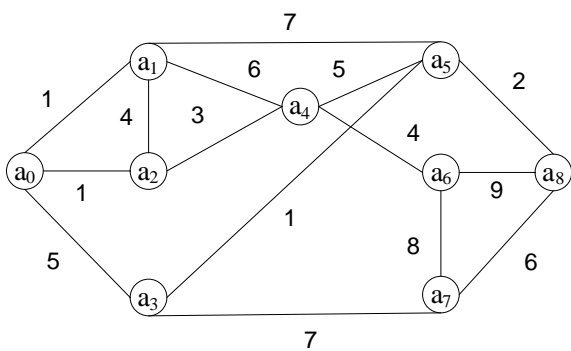

14)

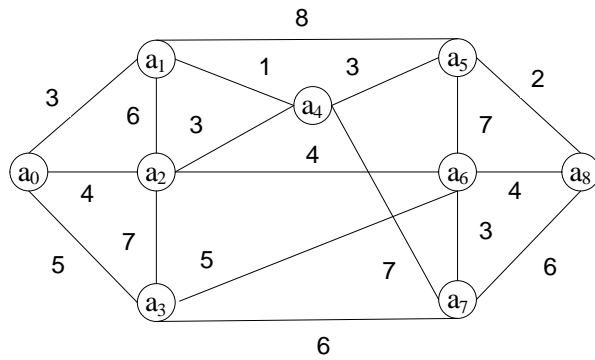

15)

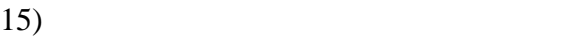

16)



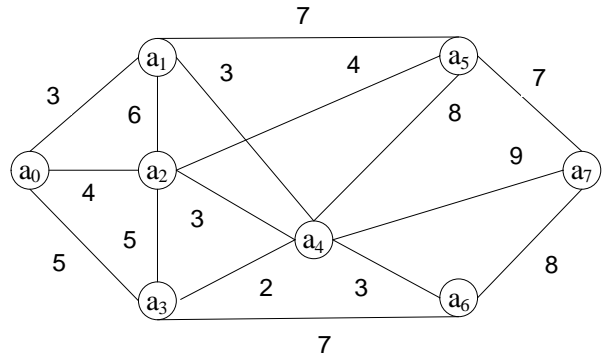
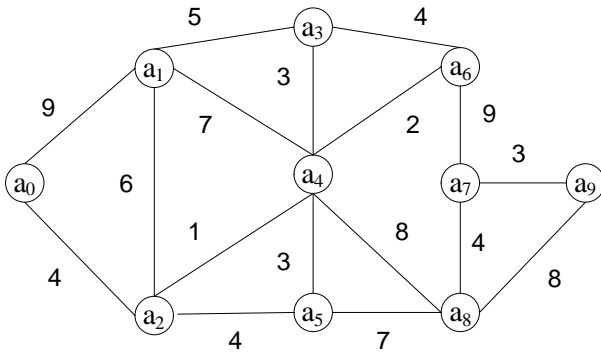

17)

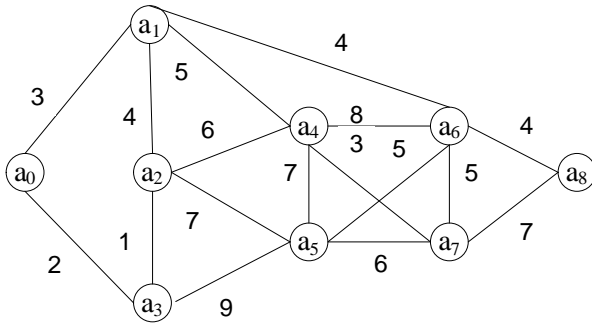

18)

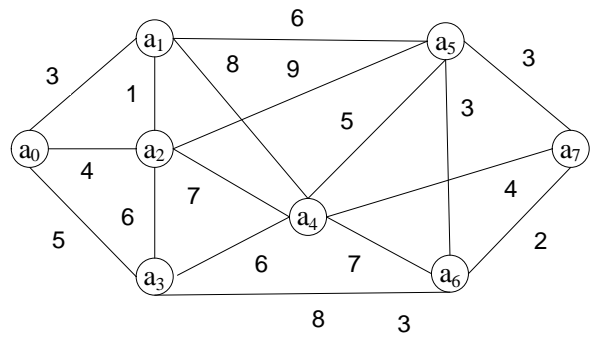

19)

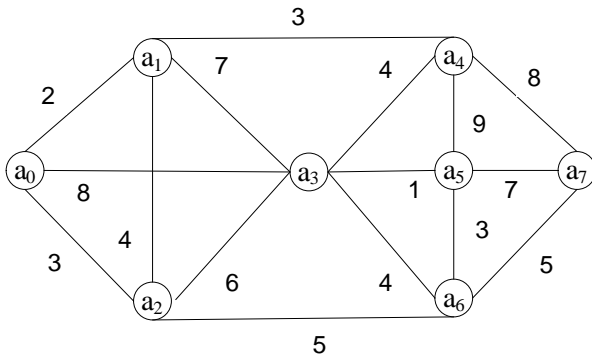

20)

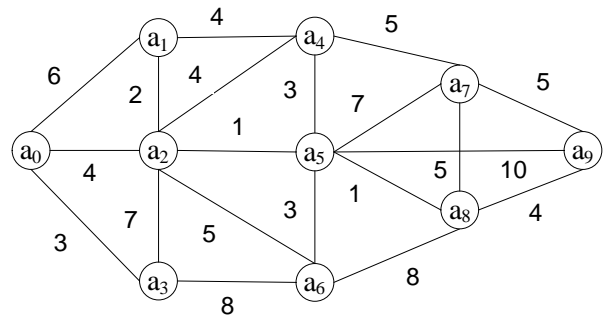

21)

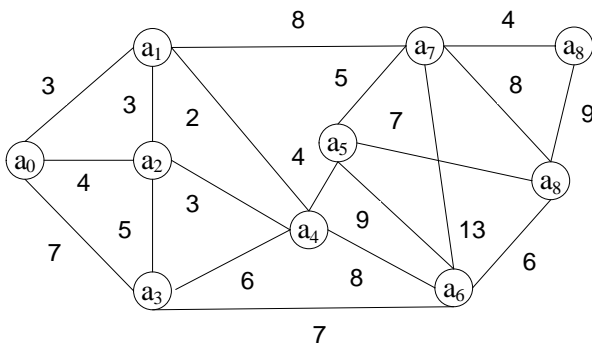

22)

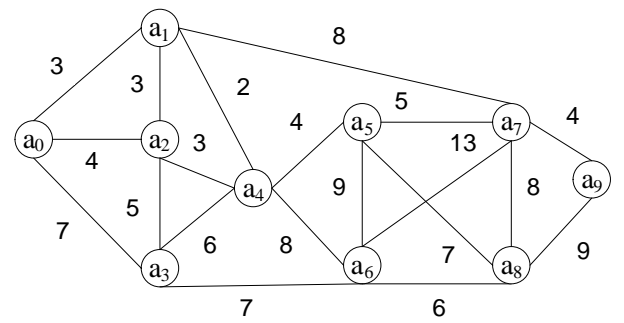

23)

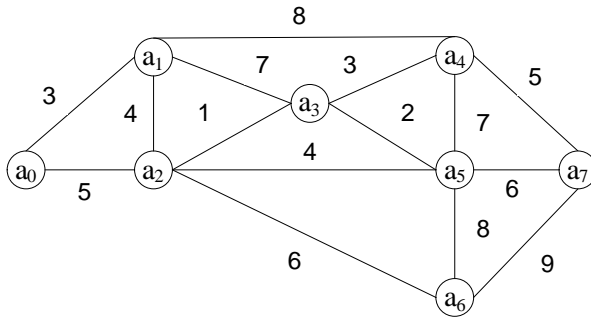

24)

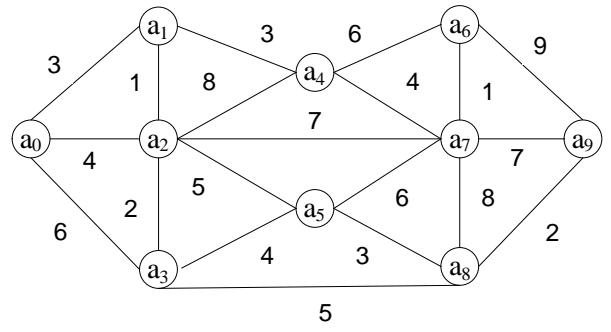

25)

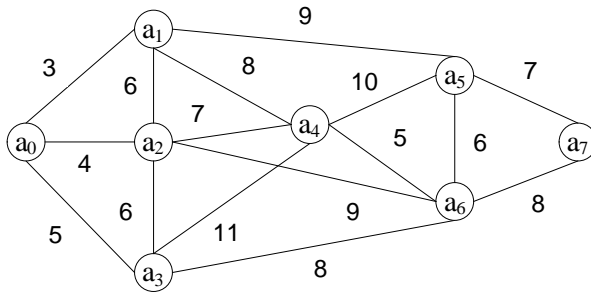

26)

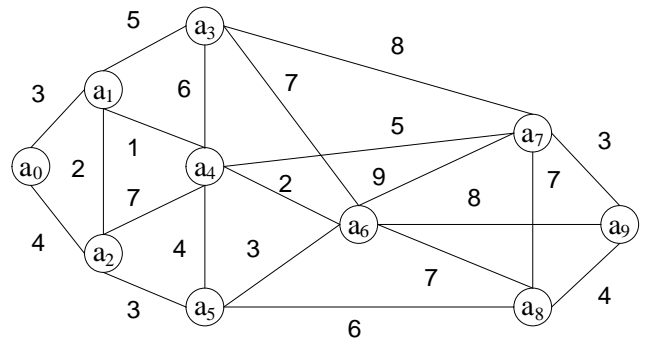

27)

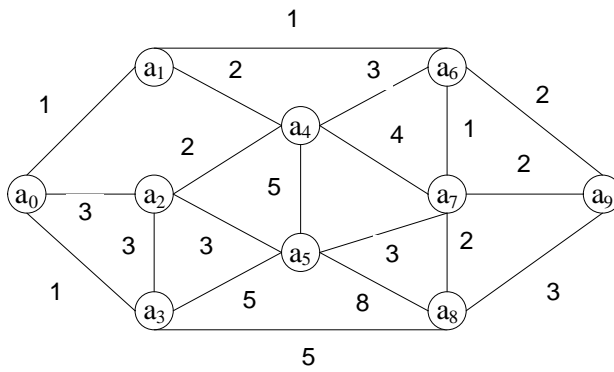

28)

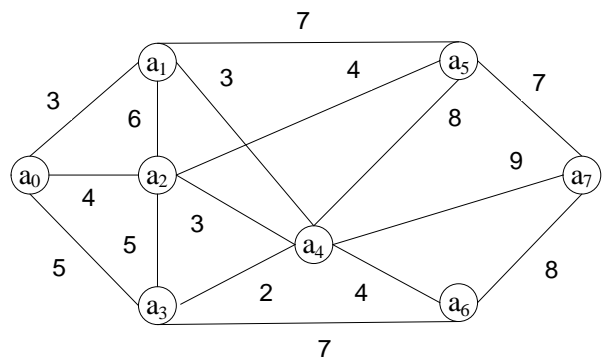

29)

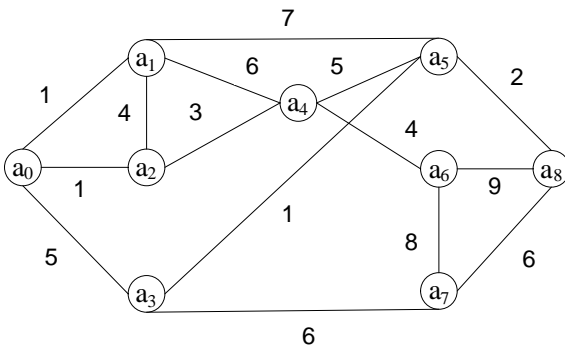

30)

